

12V

850  
CCA



105Ah

AGM

## 12CB850

Deep Cycle & Starting 12V AGM Battery

### SPECIFICATIONS

Nominal Voltage	12V	
Nominal Capacity		
100 hour rate (1.103A to 10.80V)	110.3Ah	
20 hour rate (5.25A to 10.50V)	105Ah	
10 hour rate (9.98A to 10.50V)	97.8Ah	
5 hour rate (17.85A to 10.20V)	89.3Ah	
Weight	Approx. 32kg	
Internal Resistance (at 1KHz)	Approx. 4.5mΩ	
Cold Cranking Amps (CCA) (-17.8°C)	850A	
Marine Cranking Amps (MCA) (0°C)	1065A	
Reserve Capacity (RC) (25°C)	205min 25A to 10.50V	
Charge Methods at 25°C		
Cycle Use		
Charging Voltage	13.8V to 14.6V	
Coefficient -5.0mV/°C/Cell		
Recommended Charging Current	31.5A	
Standby Use		
Float Charging Voltage	13.4V to 13.6V	
Coefficient -3.0mV/°C/Cell		
Operating Temperature Range		
Charge	-15°C to 40°C	
Discharge	-15°C to 50°C	
Storage	-15°C to 40°C	
Charge Retention (Shelf Life) at 20°C		
1 month	98%	
3 months	94%	
6 months	85%	
Case Material	ABS UL94 HB	
Termination	Dual post terminal	
Classified as a non-spillable battery. Approved for transportation by:		
• Air (IATA/ICAO provision A67)		
• Road		
• Sea (per IMDG Special Provision 238)		
Barcode	 9319632521335	



**Upright orientation recommended** - Can be mounted on any side (except upside down). Use upright position for the best service life.

### DIMENSIONS

mm (inch)

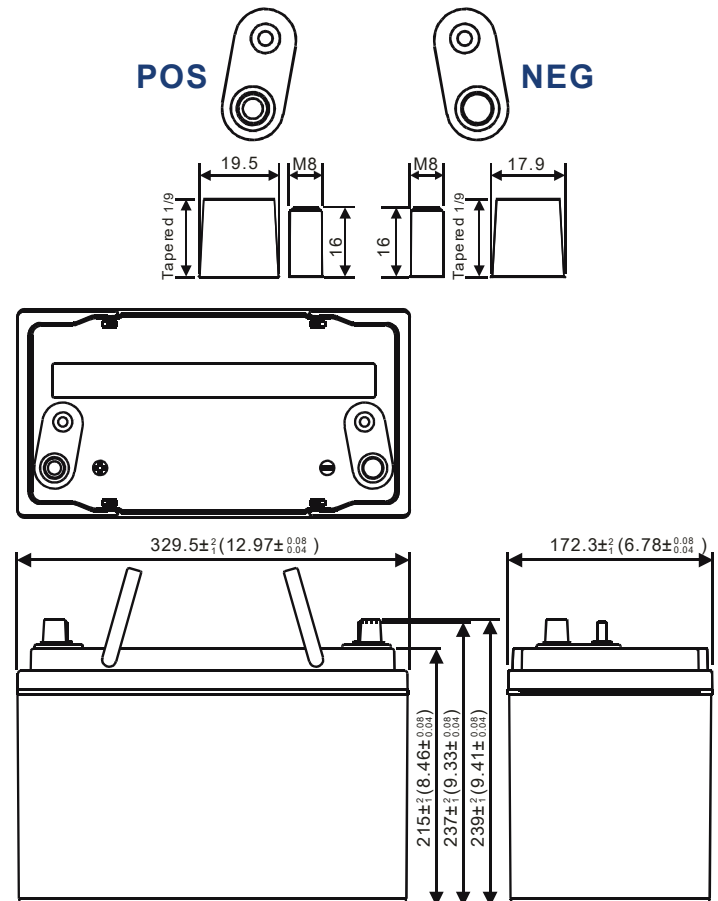

### CHARACTERISTICS CHARTS

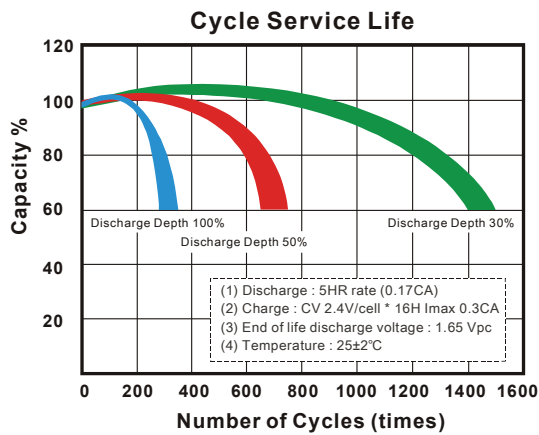
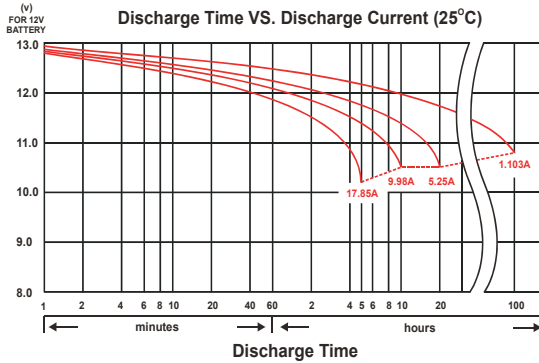

### Effect of Temperature on Capacity 25°C

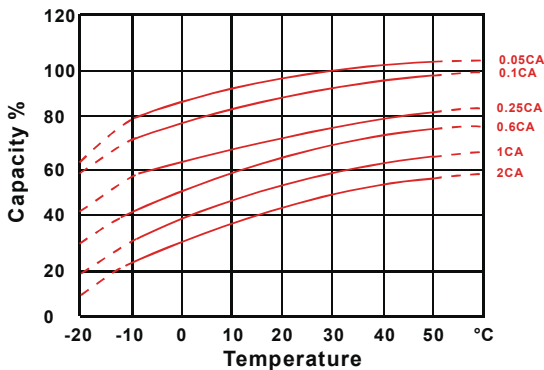

### Capacity Retention Characteristic

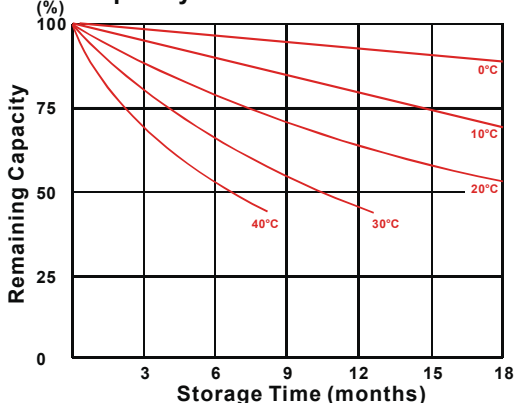

### INTERNAL FEATURES

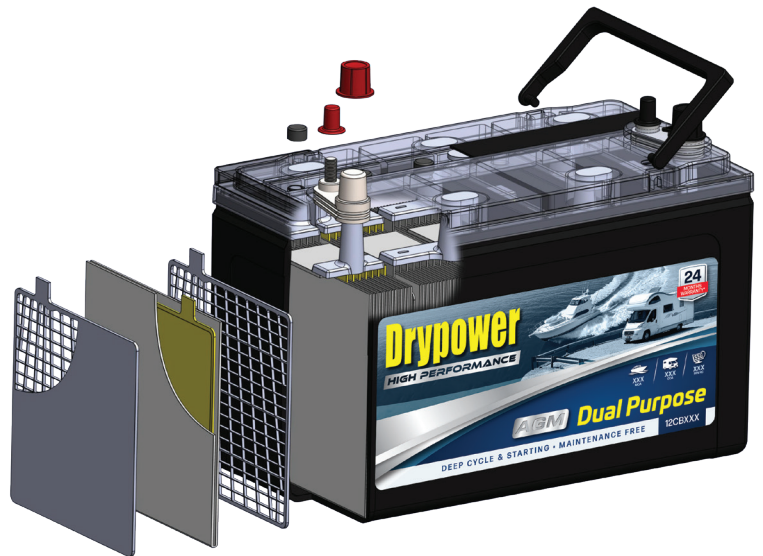

- Cast-on-Strap (COS) manufacture process providing a thicker cast for more consistent cell assembly, improved discharge performance and lower electrical resistance to promote longer service life.
- Flame arrester safety system to mitigate leakage, prevent dust exposure and minimise spark related issues.
- Rugged UL94HB ABS casing, vibration & explosion proof tested to JIS C 8702:2009 & 8701:2006.
- Enhanced Nanoscale carbon formula plate paste to reduce water loss and improves charge acceptance for superior performance and cycle life.
- Hi-tech AGM separator can absorb and trap electrolyte, preventing loss whilst promoting conductivity.

### FEATURES & BENEFITS

- Maintenance free, non-spillable design for hassle-free installation and service life.
- Dual terminal setup (AUTO POST and STUD) to designed to provide secure and reliable connections between the battery and auxiliary power loads.
- Exceptional cranking/starting power with better cold start performance when compared to conventional lead acid batteries.
- True deep cycle capability to provide reliable power to house power demands, accessory loads or even trolling motor use.
- Vibration proof design and rated for Under-Bonnet use.
- Integrated ergonomic carry handle for safe handling and installation.
- Lower self-discharge performance compared to conventional batteries means longer shelf or storage life.
- Practical mounting options to suit a variety of applications and fitment locations. Can be mounted on any side - except upside down.
- UL approved.
- 24 month warranty for private use, 12 months for commercial use.

Performance may vary depending on application. All specifications are correct at time of creation. All specifications and operation conditions contained in this datasheet are subject to change or improvement without prior notice to the user. This data is for evaluation purposes only. No guarantee is intended or implied by this data. For clarification and updated information, please contact us. Oct2023